

C E S A R

D E S I G N

S Y S T E M

Edition 06.2024
FR — ES

The kitchen planning

OUVERTURES

Métodos de apertura

GORGE / Ranura

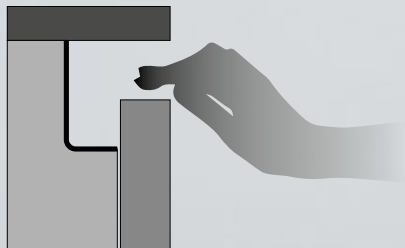

GORGE EN "L"
Ranura en "L"

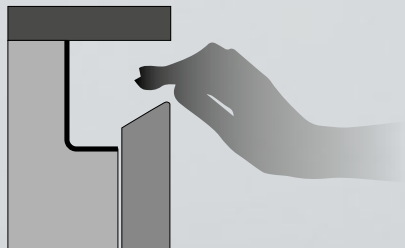

GORGE EN "L" 30°
Ranura en "L" 30°

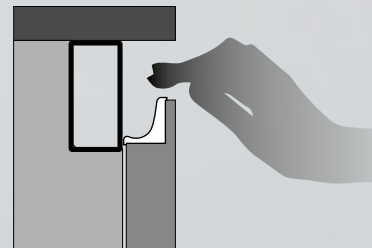

GORGE "DROITE" AVEC POIGNÉE ENCASTRÉE
Ranura "Recta" con tirador acanalado

PUSH - PULL

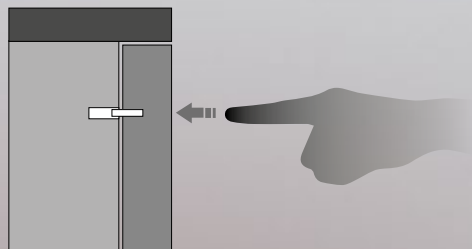

PUSH PULL

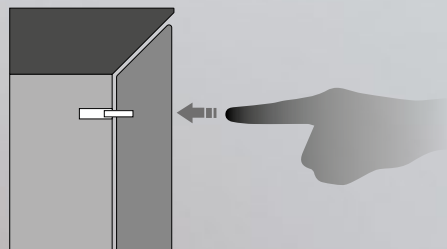

PUSH PULL 45°

POIGNÉE / Tirador

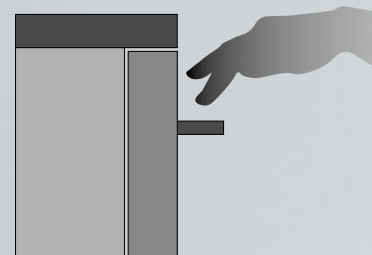

PRISES DE MAIN / Tiradores acanalados

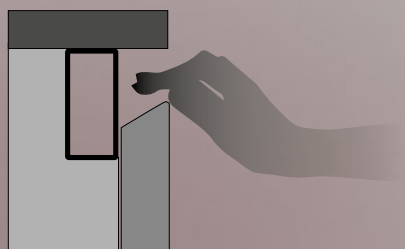

PRISE DE MAIN 30°
Tirador acanalado 30°

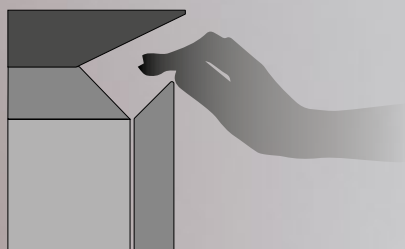

PRISE DE MAIN 45°
Tirador acanalado 45°

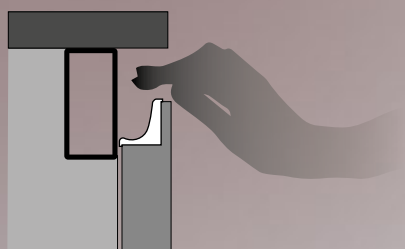

PRISE DE MAIN "FRAME"
Tirador acanalado "Frame"

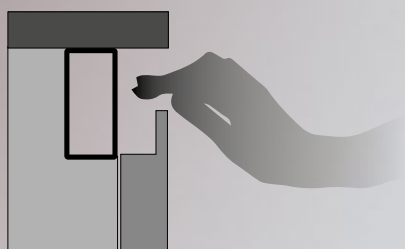

PRISE DE MAIN "STEP"
Tirador acanalado "Step"

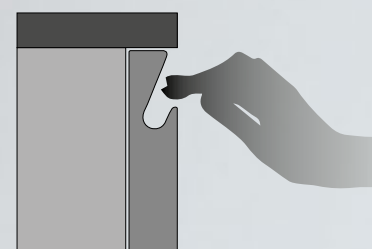

PRISE DE MAIN "INSIDE"
Tirador acanalado "Inside"

COLLECTIONS

Colecciones

UNIT



22 mm
0 55/64 inch

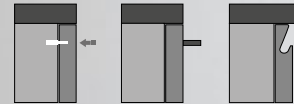

MAXIMA 2.2



22 mm
0 55/64 inch

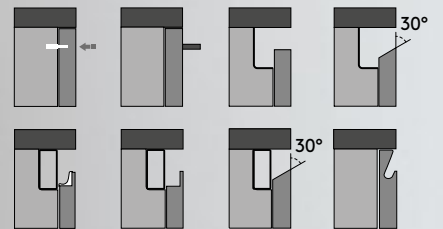

INTARSIO



22 mm
0 55/64 inch

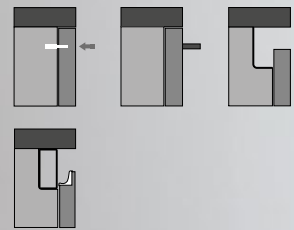

TANGRAM



22 mm
0 55/64 inch

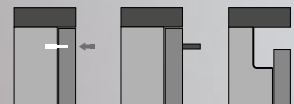

N_ELLE



22 mm
0 55/64 inch

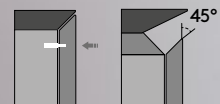

MODULARITÉ

Modularidad

MAXIMA 2.2 INTARSIO

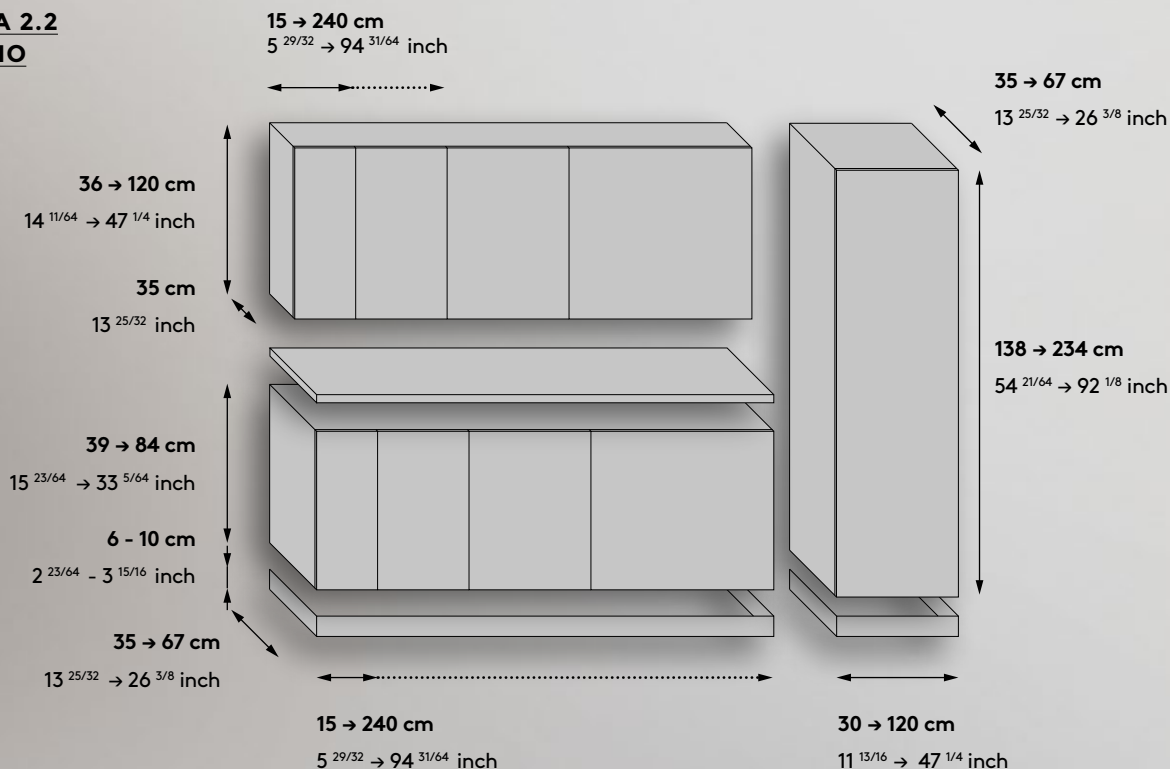

N _ELLE & N _ELLE PORTE À CADRE * / N _Elle & N _Elle puerta con marco*

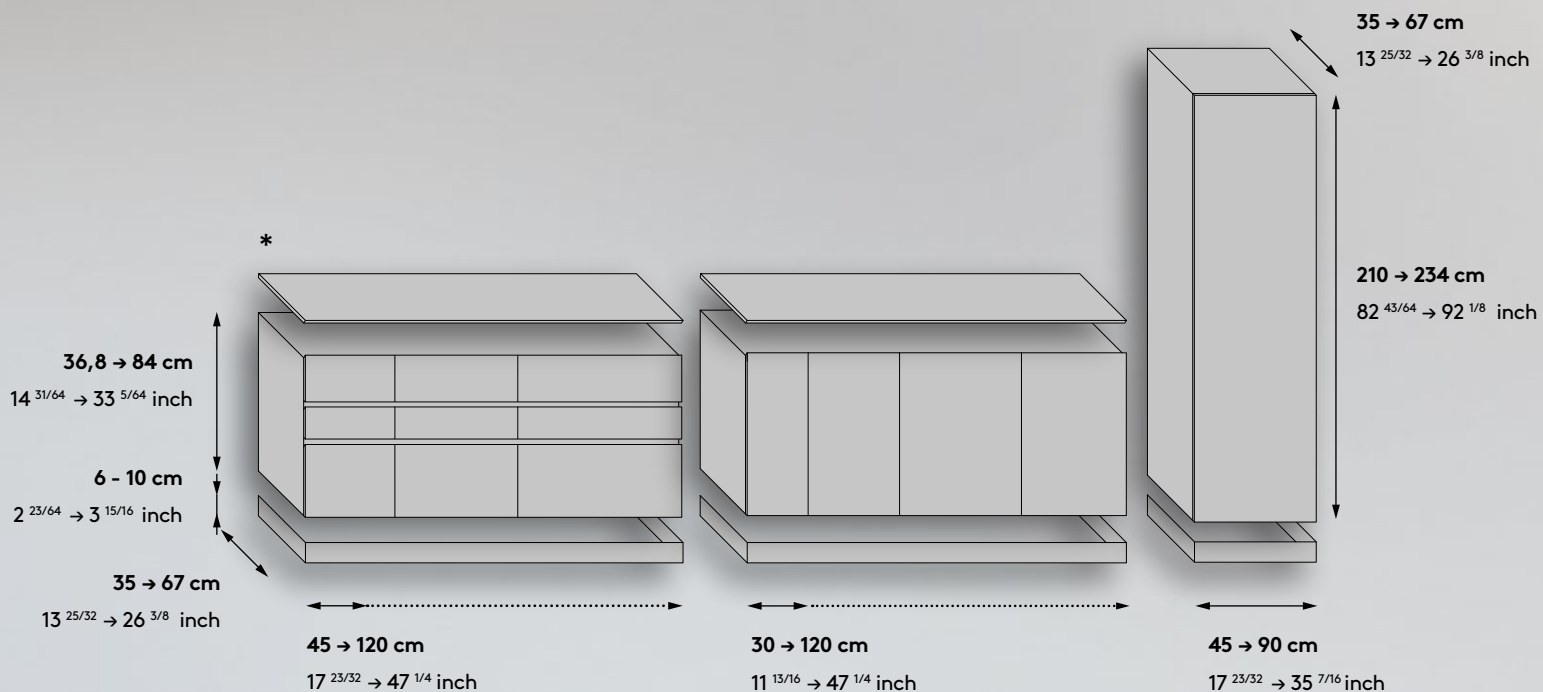

Vaste possibilité de personnaliser nos modules pour réaliser des projets sur mesure. Pour approfondir le sujet, consulter notre tarif.
Amplia posibilidad de personalizar los módulos para proyectos a la medida. Para conocer más detalles, consultar la tarifa.

MODULARITÉ

Modularidad

UNIT

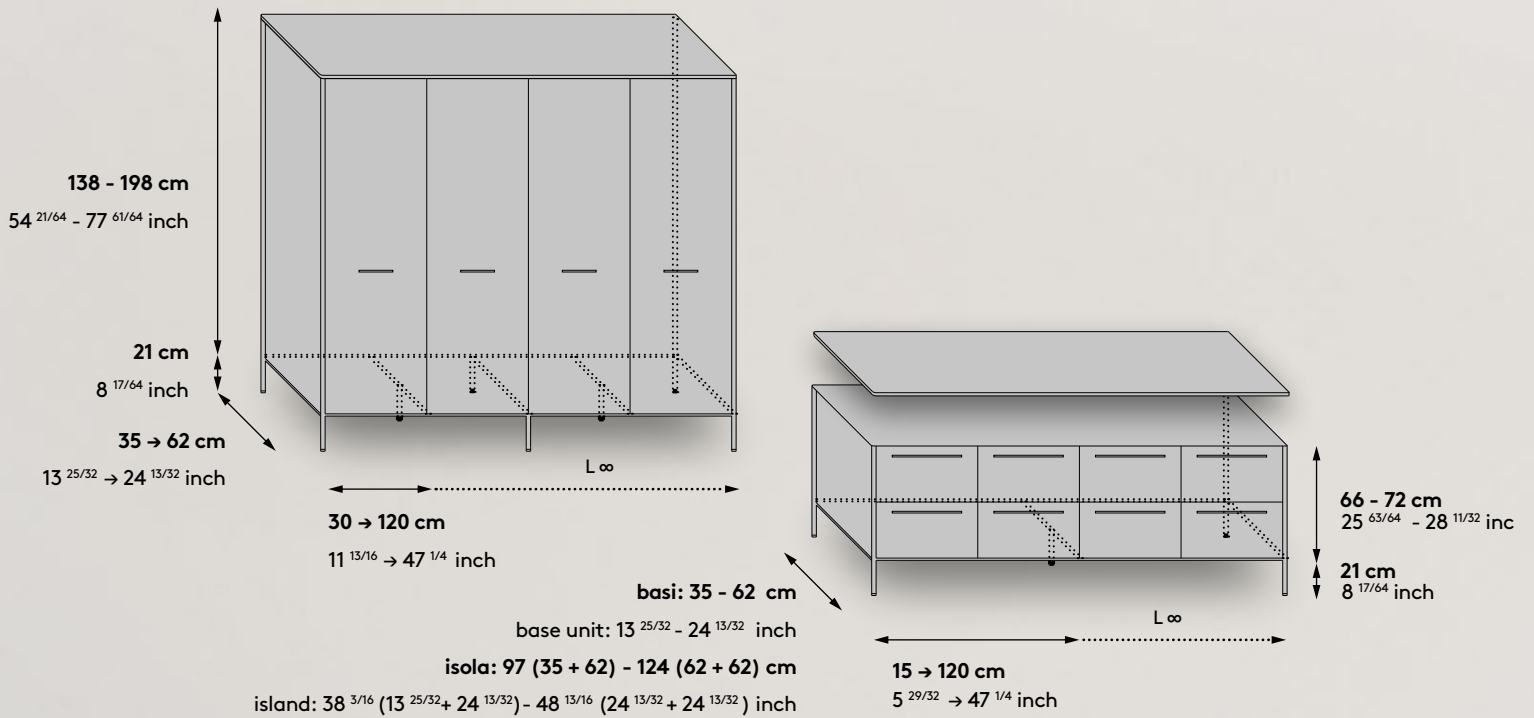

UNIT POCKET VARIANTE DOUBLE FACE & VARIANTE MURAL / Unit Pocket de un solo lado & doble cara

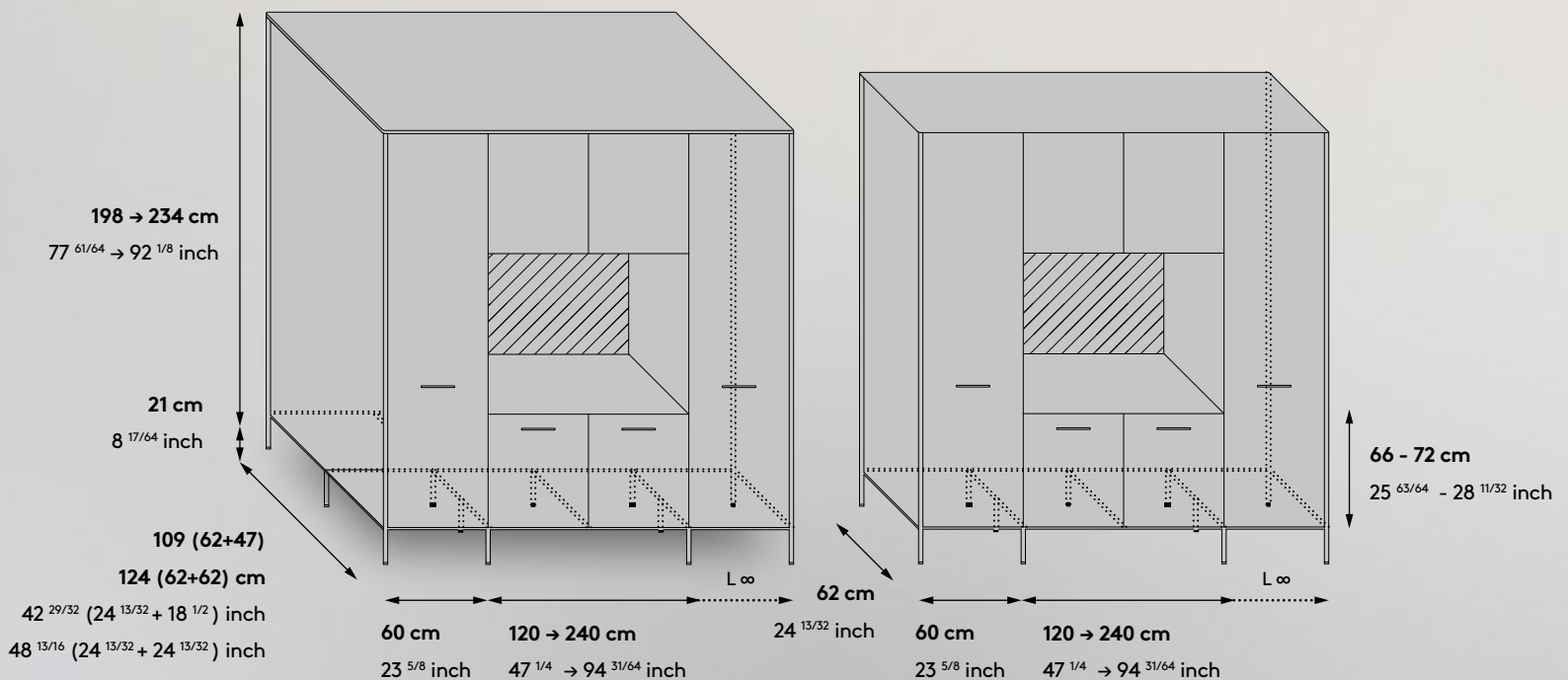

Vaste possibilité de personnaliser nos modules pour réaliser des projets sur mesure. Pour approfondir le sujet, consulter notre tarif.
 Amplia posibilidad de personalizar los módulos para proyectos a la medida. Para conocer más detalles, consultar la tarifa.

MODULARITÉ

Modularidad

TANGRAM

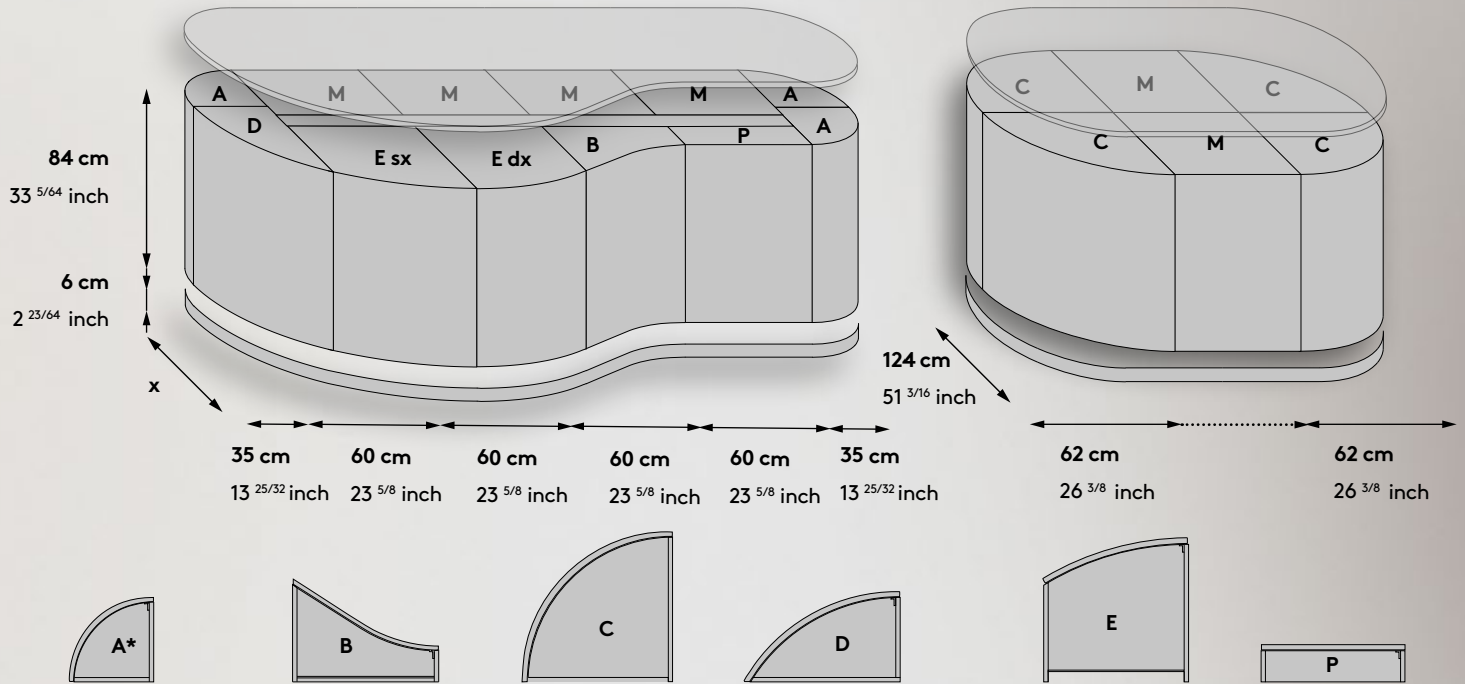

Remarque: Le module A peut également être H 138 cm, tous les modules peuvent être gauche/droite, les modules M représentent la modularité Maxima.
 Nota: El módulo A también puede tener una altura de 138 cm, todos los módulos pueden ser izquierdo/derecho, los módulos M representan la modularidad Maxima.

EXEMPLES DE COMPOSITIONS / Ejemplos de composición

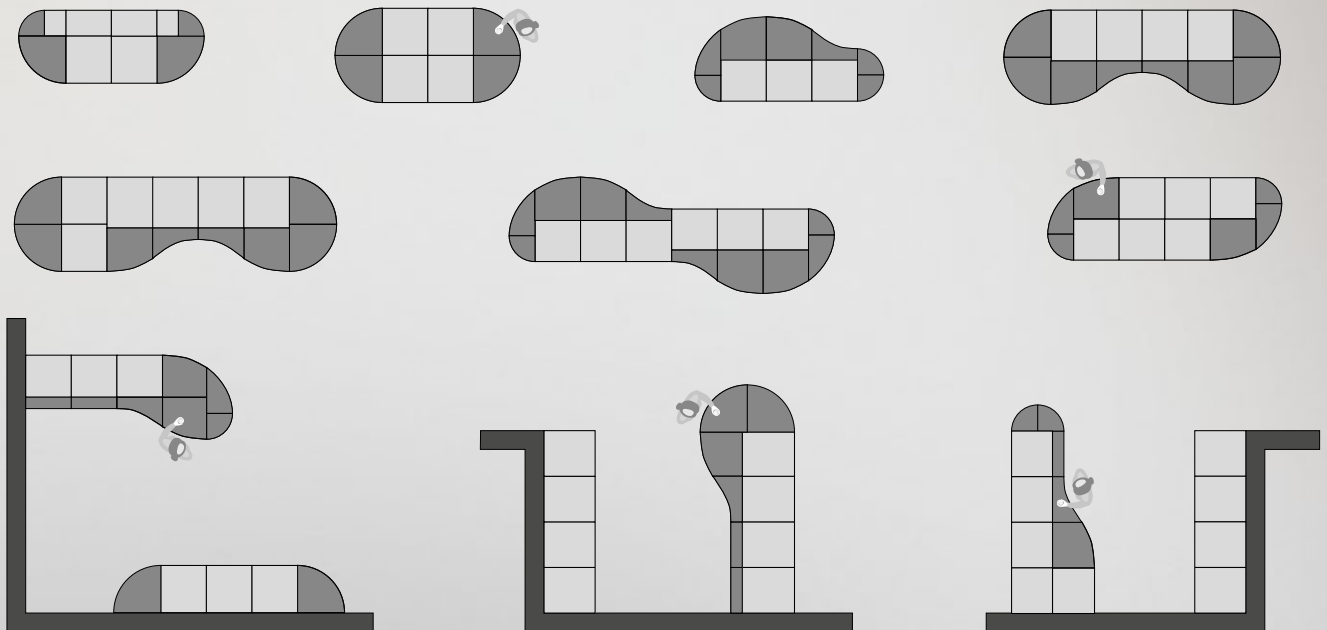

Vaste possibilité de personnaliser nos modules pour réaliser des projets sur mesure. Pour approfondir le sujet, consulter notre tarif.
 Amplia posibilidad de personalizar los módulos para proyectos a la medida. Para conocer más detalles, consultar la tarifa.

ERGONOMIE Ergonomía

PROFONDEUR DU PLAN DE TRAVAIL / Profundidad de la encimera

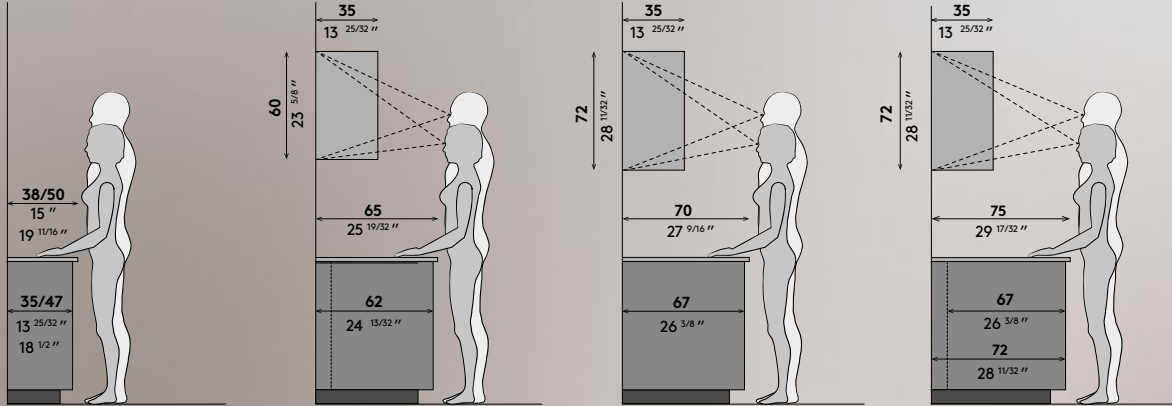

PROFONDEUR DES ÉLÉMENTS BAS ET TIROIRS / Profundidad de muebles bajos y cajones

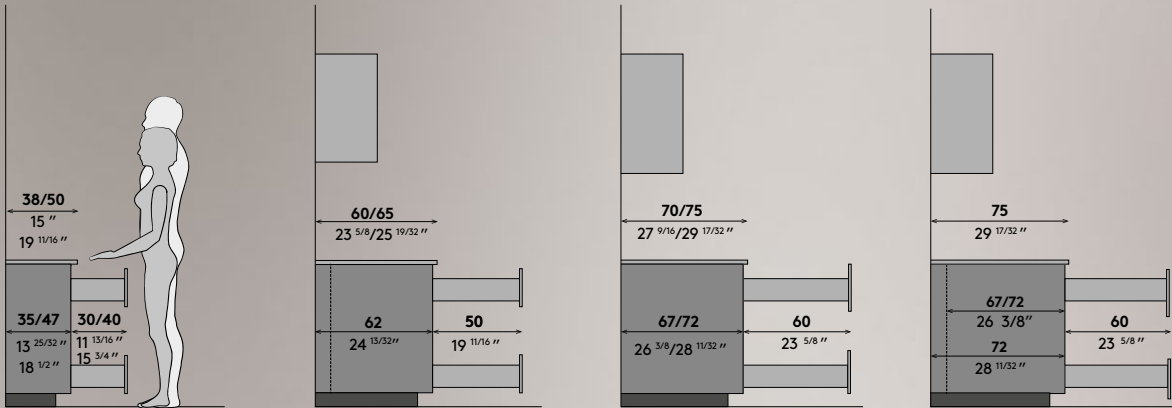

PROFONDEUR UNIT / Unit profundidad

